



ULXD6-8

Boundary and Gooseneck Base Transmitters

Online user guide for ULXD6 and ULXD8 transmitters.
Version: 9.1 (2020-L)

Table of Contents

ULXD6-8 Boundary and Gooseneck Base Transmitters	3	Wireless Workbench and IR Sync	13
IMPORTANT SAFETY INSTRUCTIONS	3	Receiver Front Panel	13
WARNING	4	Using QLX-D with a Shure ULX-D System	14
Quickstart Instructions	4	Mute/Active Button	14
General Description	5	High-Pass Filter	15
Included Components	5	Transmitter RF Power	15
Optional Accessories	5	Locking Transmitter Controls	15
Model Variations	6	Setting Initial State From Charger	16
Transmitter Controls and Connectors	7	Audio Signal Encryption	16
Connecting Gooseneck Microphone to ULXD8 Base	8	Encrypting a Single Transmitter to a Single Receiver	16
Boundary Microphone Placement	9	Removing Encryption	16
Batteries	9	BN and GN OFFSET	16
Installation	9	Transmitter Reset	16
Shure Rechargeable Batteries	10	Frequency Range	17
Charging	10	Specifications	18
Battery Runtime Charts	11	Important Product Information	21
Changing Transmitter Settings	12	LICENSING INFORMATION	21
Wireless Workbench and Networked Docking Station (recommended)	12	Certifications	21
		Information to the user	21

ULXD6-8

Boundary and Gooseneck Base Transmitters



IMPORTANT SAFETY INSTRUCTIONS

1. READ these instructions.
2. KEEP these instructions.
3. HEED all warnings.
4. FOLLOW all instructions.
5. DO NOT use this apparatus near water.
6. CLEAN ONLY with dry cloth.
7. DO NOT block any ventilation openings. Allow sufficient distances for adequate ventilation and install in accordance with the manufacturer's instructions.
8. DO NOT install near any heat sources such as open flames, radiators, heat registers, stoves, or other apparatus (including amplifiers) that produce heat. Do not place any open flame sources on the product.
9. DO NOT defeat the safety purpose of the polarized or grounding type plug. A polarized plug has two blades with one wider than the other. A grounding type plug has two blades and a third grounding prong. The wider blade or the third prong are provided for your safety. If the provided plug does not fit into your outlet, consult an electrician for replacement of the obsolete outlet.
10. PROTECT the power cord from being walked on or pinched, particularly at plugs, convenience receptacles, and the point where they exit from the apparatus.
11. ONLY USE attachments/accessories specified by the manufacturer.
12. USE only with a cart, stand, tripod, bracket, or table specified by the manufacturer, or sold with the apparatus. When a cart is used, use caution when moving the cart/apparatus combination to avoid injury from tip-over.



13. UNPLUG this apparatus during lightning storms or when unused for long periods of time.
14. REFER all servicing to qualified service personnel. Servicing is required when the apparatus has been damaged in any way, such as power supply cord or plug is damaged, liquid has been spilled or objects have fallen into the apparatus, the apparatus has been exposed to rain or moisture, does not operate normally, or has been dropped.
15. DO NOT expose the apparatus to dripping and splashing. DO NOT put objects filled with liquids, such as vases, on the apparatus.
16. The MAINS plug or an appliance coupler shall remain readily operable.
17. The airborne noise of the Apparatus does not exceed 70dB (A).
18. Apparatus with CLASS I construction shall be connected to a MAINS socket outlet with a protective earthing connection.
19. To reduce the risk of fire or electric shock, do not expose this apparatus to rain or moisture.
20. Do not attempt to modify this product. Doing so could result in personal injury and/or product failure.
21. Operate this product within its specified operating temperature range.

WARNING: Voltages in this equipment are hazardous to life. No user-serviceable parts inside. Refer all servicing to qualified service personnel. The safety certifications do not apply when the operating voltage is changed from the factory setting.

	This symbol indicates that dangerous voltage constituting a risk of electric shock is present within this unit.
	This symbol indicates that there are important operating and maintenance instructions in the literature accompanying this unit.

WARNING: Danger of explosion if incorrect battery replaced. Operate only with AA batteries.

WARNING

- Battery packs may explode or release toxic materials. Risk of fire or burns. Do not open, crush, modify, disassemble, heat above 140°F (60°C), or incinerate.
- Follow instructions from manufacturer
- Only use Shure charger to recharge Shure rechargeable batteries
- **WARNING:** Danger of explosion if battery incorrectly replaced. Replace only with same or equivalent type.
- Never put batteries in mouth. If swallowed, contact your physician or local poison control center
- Do not short circuit; may cause burns or catch fire
- Do not charge or use battery packs other than Shure rechargeable batteries
- Dispose of battery packs properly. Check with local vendor for proper disposal of used battery packs.
- Batteries (battery pack or batteries installed) shall not be exposed to excessive heat such as sunshine, fire or the like
- Do not immerse the battery in liquid such as water, beverages, or other fluids.
- Do not attach or insert battery with polarity reversed.
- Keep away from small children.
- Do not use abnormal batteries.
- Pack the battery securely for transport.

Please follow your regional recycling scheme for batteries, packaging, and electronic waste.

Quickstart Instructions

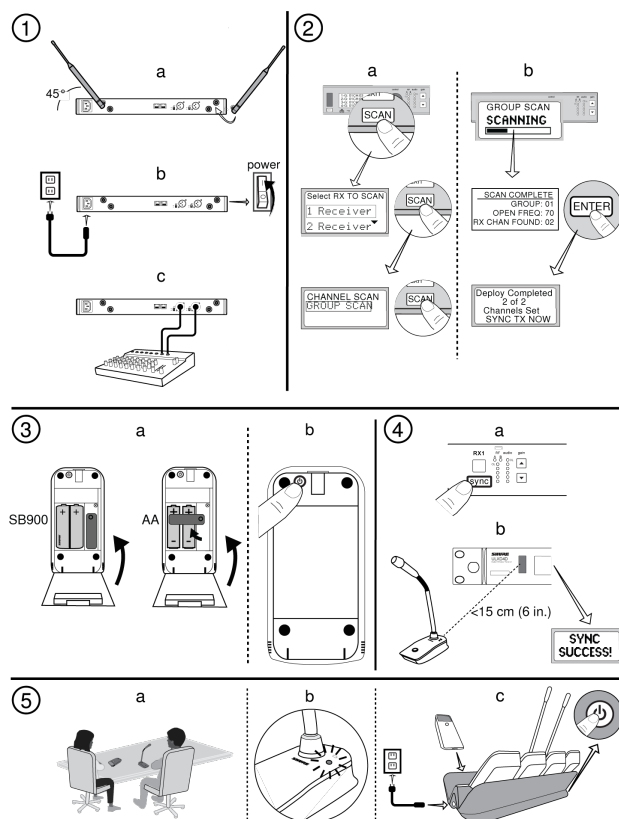

General Description

ULX-D series boundary and gooseneck base transmitters add new designs to Shure's breakthrough ULX-D wireless line. Boundary and gooseneck base transmitters offer cable-free flexibility for corporate conference rooms, government facilities, educational institutions, A/V conferencing, and live sound reinforcement. Use Shure Wireless Workbench[®] software and networked docking stations to simplify transmitter configuration and monitor charging status.

Both transmitters run on rechargeable or AA batteries and can be monitored using external control systems, such as AMX or Crestron. ULX-D systems also offer audio signal encryption, high-density mode, and Dante[™] digital networking for multi-channel audio over Ethernet.

Included Components

- AA Batteries

Optional Accessories

4-bay networked docking station for gooseneck and boundary microphones	SBC450
8-bay networked docking station for gooseneck and boundary microphones	SBC850
8-Bay Shure Battery Charger	SBC800
6' USB-A cable with wall plug for charging Wireless Transmitters	SBC10-USB-A
Shure Lithium-Ion Rechargeable Battery	SB900A

Model Variations

ULXD Cardioid Boundary Microphone	ULXD6/C
ULXD Omnidirectional Boundary Microphone	ULXD6/O
ULXD Gooseneck Base Transmitter	ULXD8
ULXD Cardioid Boundary Microphone (white)	ULXD6W/C
ULXD Omnidirectional Boundary Microphone (white)	ULXD6W/O
ULXD Gooseneck Base Transmitter (white)	ULXD8W
5" Cardioid Gooseneck Microphone	MX405LP/C
5" Supercardioid Gooseneck Microphone	MX405LP/S
5" Mini-shotgun Gooseneck Microphone	MX405LP/MS
5" Gooseneck with Red Top LED (no cartridge)	MX405RLP/N
10" Cardioid Gooseneck Microphone	MX410LP/C
10" Supercardioid Gooseneck Microphone	MX410LP/S
10" Gooseneck with Red Top LED (no cartridge)	MX410RLP/N
10" Cardioid Dualflex Gooseneck Microphone	MX410LPDF/C
10" Supercardioid Dualflex Gooseneck Microphone	MX410LPDF/S
10" Dualflex Gooseneck with Red Top LED (no cartridge)	MX410RLPDF/N
10" Cardioid Dualflex Gooseneck Microphone with Red Top LED	MX410RLPDF/C
10" Supercardioid Dualflex Gooseneck Microphone with Red Top LED	MX410RLPDF/S
15" Cardioid Gooseneck Microphone	MX415LP/C
15" Supercardioid Gooseneck Microphone	MX415LP/S
15" Gooseneck with Red Top LED (no cartridge)	MX415RLP/N

15" Cardioid Dualflex Gooseneck Microphone	MX415LPDF/C
15" Supercardioid Dualflex Gooseneck Microphone	MX415LPDF/S
15" Dualflex Gooseneck with Red Top LED (no cartridge)	MX415RLPDF/N
15" Cardioid Dualflex Gooseneck Microphone with Red Top LED	MX415RLPDF/C
15" Supercardioid Dualflex Gooseneck Microphone with Red Top LED	MX415RLPDF/S
5" White Gooseneck Microphone (no cartridge)	MX405WLP/N
5" White Gooseneck Microphone with Red Top LED (no cartridge)	MX405WRLP/N
10" White Gooseneck Microphone (no cartridge)	MX410WLP/N
10" White Gooseneck Microphone with Red Top LED (no cartridge)	MX410WRLP/N
15" White Gooseneck Microphone (no cartridge)	MX415WLP/N
15" White Gooseneck Microphone with Red Top LED (no cartridge)	MX415WRLP/N
10" White Dualflex Gooseneck Microphone (no cartridge)	MX410WLPDF/N
10" White Dualflex Gooseneck Microphone with Red Top LED (no cartridge)	MX410WRLPDF/N
15" White Dualflex Gooseneck Microphone (no cartridge)	MX415WLPDF/N
15" White Dualflex Gooseneck Microphone with Red Top LED (no cartridge)	MX415WRLPDF/N

Transmitter Controls and Connectors

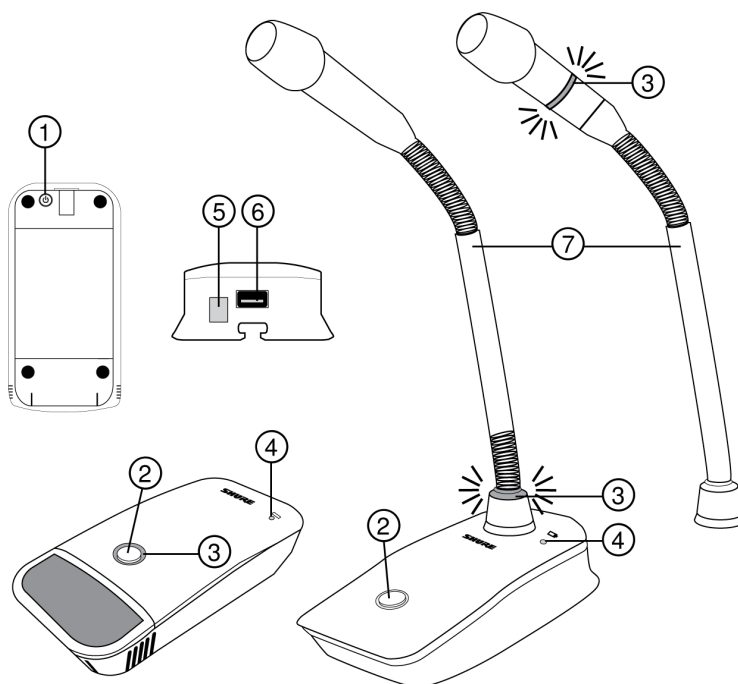

① Power Button

Press to power on; press and hold to power off.

② Mute/Active Button

Four settings are available for the mute/active button:

- Toggle: Press to switch between active and mute states
- Push-to-Mute: Hold button to mute microphone
- Push-to-Talk: Hold button to activate microphone
- Disabled: Button functionality off

③ Mute LED

Indicates whether microphone is active or muted. The following settings are available:

Active	Muted
Green*	Red*
Red	Off
Red	Flashing red

*MX400R series gooseneck microphones (red LED) do not offer this setting.

④ Low-Battery LED

- Off = More than 30 minutes of battery life remain
- On (red) = Less than 30 minutes of battery life remain
- On (green) = Microphone docked on charging station
- On (amber) = Battery is missing or is not inserted correctly

⑤ Infrared (IR) Port

Align with receiver IR port to send settings to transmitter.

⑥ Charge Connector

Connects to networked chargers and USB power supply.

⑦ Gooseneck Microphone

ULXD8 base fits 5", 10", and 15" Microflex series microphones. Gooseneck microphones are available in single or dualflex models and with bi-color or red-only LEDs.

Connecting Gooseneck Microphone to ULXD8 Base

ULXD8 base transmitters fit 5", 10", and 15" Microflex series gooseneck microphones, available in single and dualflex models. Connect microphone to base as shown.

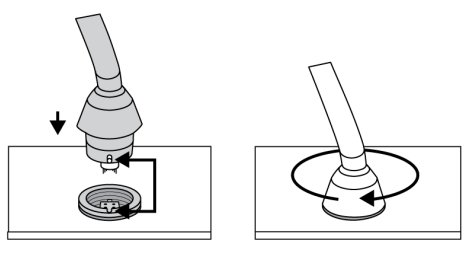

Boundary Microphone Placement

The boundary transmitter sits on a table or desk to transmit speech while discreetly blending into any conference environment. Cardioid and omnidirectional versions are available.

For best low-frequency response and rejection of background noise, place the microphone on a large, flat surface, such as a floor, table, or lectern.

To reduce reverberance, avoid reflective surfaces above or to the side of the microphone, such as beveled sides of pulpits or overhanging shelves.

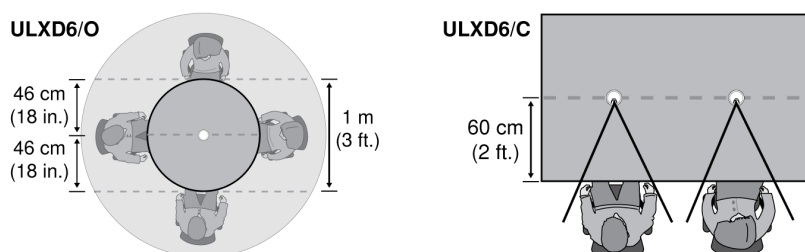

Batteries

Boundary and gooseneck base transmitters can be powered by Shure rechargeable batteries or two AA batteries (included).

The receiver front panel displays battery charge level in hours/minutes for Shure batteries and in bars for AA batteries. For accurate monitoring, set battery type in the IR Presets menu using the receiver front panel or Wireless Workbench and perform an IR sync.

Menu path: IR PRESETS > GOOSENECK / BOUNDARY > BATTERY

Installation

1. Open the battery door.
2. Insert one Shure battery or two AA batteries. Align +/- terminals on batteries as shown. For AA batteries, rotate the rubber piece to hold batteries in place.
3. Close the battery door until it latches.

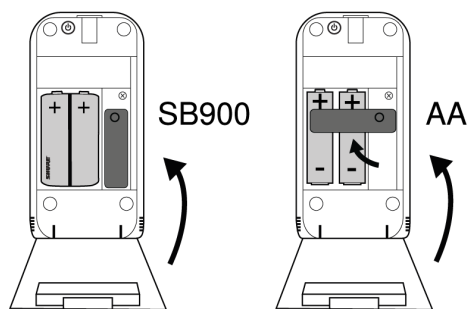

Use the small screw to the right of the batteries to secure the battery door against tampering, if necessary.

1. Open the battery door.
2. Use a screwdriver to remove the screw to the right of the battery.
3. Close the battery door.
4. Insert and tighten the screw using a screwdriver.

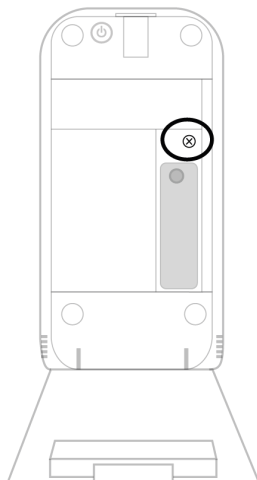

Shure Rechargeable Batteries

The receiver home screen displays the number of hours and minutes remaining for rechargeable batteries. If using a networked docking station, Wireless Workbench displays battery information for all docked transmitters.

Detailed information for rechargeable batteries is displayed in the receiver BATTERY INFO menu.

HEALTH: Displays battery health as a percentage of the charge capacity of a new battery.

CHARGE: Percentage of a full charge

CYCLES: Number of times the battery has been charged

TEMP: Battery temperature in Celsius and Fahrenheit

Charging

Charge transmitters with Shure rechargeable batteries in a networked docking station.

Note: Turning off a networked docking station also turns off any docked transmitters. Transmitters will resume charging when the power is restored.

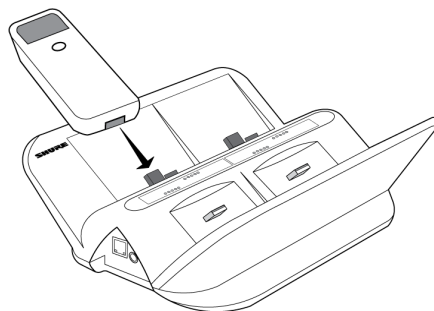

To provide power during operation, connect to an optional Shure USB power supply (SBC10-USB-A).

The SBC10 power supply and the SBC450 and SBC850 docking stations fully charge Shure rechargeable batteries in about three hours.

Battery Runtime Charts

For AA batteries, the battery icon on the receiver front panel indicates battery charge.



The following tables display the approximate hours and minutes remaining (hh:mm) for each battery indicator.

Alkaline





Battery Life	10 mW
	8:00 to 5:55
	5:55 to 3:50
	3:50 to 1:45
	1:45 to 0:45
	0:45 to 0:15
	0:15 to 0:00

NiMH

Battery Life	10 mW
	10:00 to 7:15
	7:15 to 4:30
	4:30 to 1:45
	1:45 to 0:45

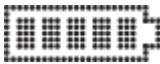
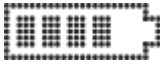
Battery Life	10 mW
	0:45 to 0:15
	0:15 to 0:00

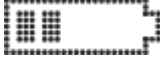
Li-primary

Battery Life	10 mW
	15:00 to 10:35
	10:35 to 6:10
	6:10 to 1:45
	1:45 to 0:45
	0:45 to 0:15
	0:15 to 0:00

Changing Transmitter Settings

Each transmitter has the following adjustable settings:

- Mute button and mute LED behavior or brightness
- High-pass filter
- RF power
- Power lock
- Initial state from charger
- Battery type
- Device name
- Channel name
- Frequency
- Normal or High-Density mode
- Boundary and gooseneck offset

There are three ways to change transmitter settings:

Wireless Workbench and Networked Docking Station (recommended)

Required equipment: Networked docking station, computer with Wireless Workbench installed, and transmitter

1. Place transmitters on charger. Check that charger is connected to network and to Wireless Workbench.
2. Open the Item Properties for the charger in Wireless Workbench.
3. Select one or multiple transmitters.
4. Make changes to transmitter settings and click Apply. Transmitters are now ready to use.

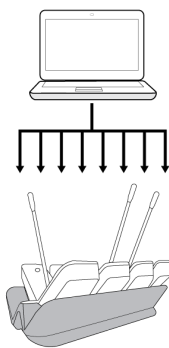

Wireless Workbench and IR Sync

Required equipment: Computer with Wireless Workbench installed, receiver, and transmitter

1. Ensure that the receiver is connected to the network and to Wireless Workbench.
2. From Wireless Workbench, access the Properties Panel for the receiver.
3. Navigate to IR Presets and set the transmitter parameters.
4. Sync the transmitter and receiver to send the settings to the transmitter.

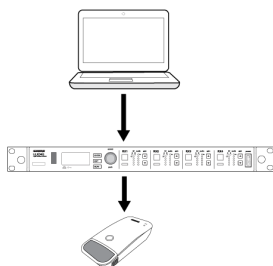

Receiver Front Panel

Required equipment: Receiver and transmitter

1. Use receiver front panel and control wheel to change transmitter settings. See receiver user guide for detailed menu structure.
2. Press enter on receiver to save changes.
3. Press sync.
4. Align the receiver and transmitter IR windows until the receiver IR window illuminates red.
5. When complete, SYNC SUCCESS! appears.

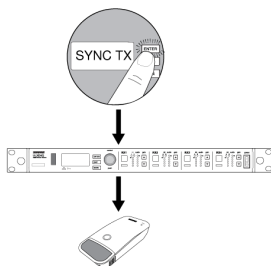

Note: If using a QLX-D receiver, you must use Wireless Workbench to make changes to transmitter settings.

Using QLX-D with a Shure ULX-D System

Transmitters and receivers from QLX-D and ULX-D component groups can be paired to form audio channels.

To ensure functionality, use the following settings on receivers and transmitters:

- Encryption set to Off
- High Density Mode set to Off (ULX-D receiver)
- Manually tune the receiver and transmitter to the same frequency.

Note: IR sync between QLX-D and ULXD6/8 transmitters is possible provided you are operating on firmware version 2.1.16 or newer.

To create an audio channel, manually set the receiver frequency to match the frequency of the transmitter.

If using ULXD6 or ULXD8 transmitters with a QLX-D receiver, you can only make changes to transmitter presets using Wireless Workbench.

1. Open receiver properties in WWB.
2. Make changes to transmitter presets and click Apply. The new settings will be sent to the QLX-D receiver.
3. On the receiver front panel, hold enter while pressing menu to enter the advanced menu.
4. Press menu to advance to Preset bn gn. The IR window will flash.

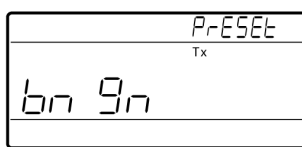

5. Align the transmitter IR window with the receiver to send the presets to the transmitter.

Important: All QLX-D and ULX-D components must use 2.0 firmware or greater for proper functionality.

Mute/Active Button

The button is configured to toggle between Mute and Active. The following options are available:

- Toggle: Press button to mute microphone, press again to pass audio
- Push-to-Talk: Hold button to pass audio
- Push-to-Mute: Hold button to mute microphone
- Disabled: Button functionality off

Change button behavior using Wireless Workbench or the receiver front panel.

Menu path: IR PRESETS > GOOSENECK / BOUNDARY > MUTE BUTTON BEHAVIOR

Note: When the mute/active button is set to Disabled, the transmitter will still send TPCI data if the button is pressed.

High-Pass Filter

Each transmitter contains a high-pass filter.

The high-pass filter:

- attenuates frequencies below 150 Hz by 12 dB per octave
- reduces low-frequency noise caused by table vibration or air handling systems

Adjust high-pass filter settings using Wireless Workbench or the receiver front panel.

Menu path: IR PRESETS > GOOSENECK / BOUNDARY > HIGH PASS

Transmitter RF Power

Reference the following table for setting RF Power:

RF Power Setting	System Range	Application
1 mW	33 m (100 ft.)	For increased channel reuse at close distances
10 mW	100 m (330 ft.)	Typical setups
20 mW	>100 m (330 ft.)	For hostile RF environments or long-distance applications

Menu path: IR PRESETS > GOOSENECK / BOUNDARY > RF POWER

Note: Using the 20 mW setting decreases the transmitter battery runtime and reduces the number of compatible systems.

Locking Transmitter Controls

Boundary and gooseneck base transmitters have a power lock to prevent accidental or unauthorized changes to the transmitter. When the power lock is on, the transmitter's power switch is disabled.

To unlock, use receiver front panel or Wireless Workbench.

Menu path: IR PRESETS > GOOSENECK / BOUNDARY > POWER LOCK

Attempting to access a locked feature will display the following message on the receiver front panel:



Setting Initial State From Charger

Use the receiver front panel or Wireless Workbench to control a transmitter's state after you remove it from a networked docking station.

- Active: On and passing audio
- Muted: On but the audio is muted
- Off: Power is off

Menu path: IR PRESETS > GOOSENECK / BOUNDARY > INITIAL STATE FROM CHARGER

Note: If Mute Button Behavior is set to Push-to-Talk and Initial State From Charger is set to Active, the transmitter will only pass audio when you push the mute button. Make sure to coordinate settings for Mute Button Behavior and Initial State From Charger.

Audio Signal Encryption

When encryption is enabled, the receiver generates a unique encryption key which is shared with the transmitter during an IR sync. Transmitters and receivers that share an encryption key form a protected audio path, preventing unauthorized access from other receivers.

Enable encryption using Wireless Workbench or the receiver front panel. For more details, see the user guide for your receiver.

Encrypting a Single Transmitter to a Single Receiver

1. From the receiver menu: DEVICE UTILITIES > ENCRYPTION > ON (Auto)
2. Press ENTER.
3. Perform an IR Sync to share the encryption key with the selected transmitter.

Removing Encryption

1. From the receiver menu: DEVICE UTILITIES > ENCRYPTION > OFF
2. Press ENTER.
3. IR Sync the transmitter and receiver to clear the encryption key.

Note: If multiple transmitters are encrypted to a single receiver, each transmitter must be IR synced to clear the encryption key.

BN and GN OFFSET

BN OFFSET and GN OFFSET compensate for signal level differences between transmitters that share the same receiver channel. For normal gain adjustments, use the receiver gain buttons.

Set the offset gain on a low signal level transmitter to match a louder transmitter: IR PRESETS > GOOSENECK / BOUNDARY > BN OFFSET

IR PRESETS > GOOSENECK / BOUNDARY > GN OFFSET

Transmitter Reset

Hold mute button while powering on transmitter to restore factory settings:

- Mute button: Toggle
- Mute LED: Active/Mute = Green/Red
- Mute LED with MX400R gooseneck: Active/Mute = Red/Off
- Initial state from charger: Active
- High-pass filter: Off
- RF power: 10 mW
- Battery type: Alkaline
- BN or GN offset: 0 dB
- Power lock: Off
- Mute LED brightness: Normal

Frequency Range

Band	Frequency Range (MHz)	Power (mW)*
G50	470 to 534	1/10/20
G51	470 to 534	1/10/20
G52	479 to 534	1/10
G53	470 to 510	1/10/20
H50	534 to 598	1/10/20
H51	534 to 598	1/10/20
H52	534 to 565	1/10
H53	534 to 598	1/10
J50	572 to 608; 614 to 636	1/10/20
J51	572 to 636	1/10/20
K51	606 to 670	1/10
K52	606 to 670	1/10
L50	632 to 696	1/10/20
L51	632 to 696	1/10/20
L52	632 to 694	1/10
L53	632 to 714	1/10/20
M19	694 to 703	1/10/20
P51	710 to 782	1/10/20

Band	Frequency Range (MHz)	Power (mW)*
P52	710 to 782	1/10
JB	806 to 810	1/10
Q12	748 to 758	1/10/20
Q51	794 to 806	1/10/20
S50	823 to 832; 863 to 865	1/10
X51	925 to 937.5	1/10
X52	902 to 928	0.25/10/20
X53	902 to 907.500; 915 to 928	0.25/10/20
X54	915 to 928	0.25/10/20

*Output power delivered to the antenna port of the transmitter.

เครื่องโพรคมนาอมและอุปกรณ์นี้มีความสอดคล้องตามมาตรฐานหรือข้อกำหนดทางเทคนิคของ กสทช.

Specifications

ULXD6

Gain Adjustment Range

0 to 21 dB (in 3 dB steps)

Battery Type

Shure SB900/SB900A Rechargeable Li-Ion or AA batteries 1.5 V

Battery Runtime

@ 10 mW

Shure SB900A	Up to 9 hours 20 minutes
AA batteries	Up to 8 hours 40 minutes

Dimensions

113.94 mm x 61.83 mm x 34.28 mm (4.48 in. x 2.43 in. x 1.35 in.) H x W x D

Weight

241 g with AA batteries

Operating Temperature Range

0°C (32°F) to 45°C (113°F)

Housing

Molded Plastic

RF Output

Antenna Type

Integrated PIFA

Impedance

50 Ω

Occupied Bandwidth

<200 kHz

Audio Frequency Response

50 Hz to 17 kHz (varies with capsule)

Modulation Type

Shure proprietary digital

Power

1 mW, 10 mW, 20 mW

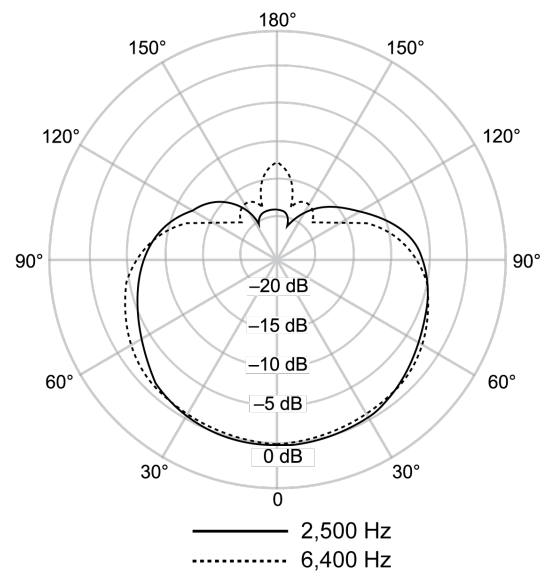
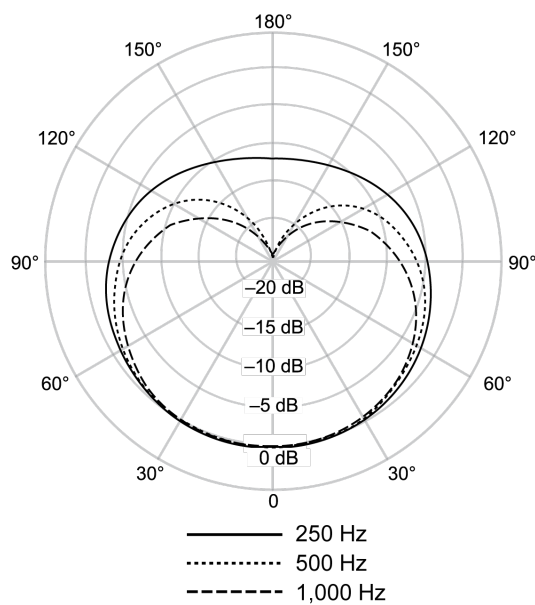

Cardioid

ULXD8

Gain Adjustment Range

0 to 21 dB (in 3 dB steps)

Battery Type

Shure SB900/SB900A Rechargeable Li-Ion or AA batteries 1.5 V

Battery Runtime

@ 10 mW

Shure SB900A	Up to 9 hours
AA batteries	Up to 8 hours 20 minutes

Dimensions

136.94 mm x 78.27 mm x 40.77 mm (5.39 in. x 3.08 in. x 1.60 in.) H x W x D

Weight

293 g with AA batteries

Operating Temperature Range

0°C (32°F) to 45°C (113°F)

Housing

Molded Plastic

Audio Input

Microphone Connector

6-pin connector for Shure MX405/10/15

Configuration

Unbalanced

Impedance

>20 k Ω

RF Output

Antenna Type

Integrated PIFA

Impedance

50 Ω

Occupied Bandwidth

<200 kHz

Audio Frequency Response

50 Hz to 17 kHz (varies with capsule)

Modulation Type

Shure proprietary digital

Power

1 mW, 10 mW, 20 mW

Important Product Information

LICENSING INFORMATION

Licensing: A ministerial license to operate this equipment may be required in certain areas. Consult your national authority for possible requirements. Changes or modifications not expressly approved by Shure Incorporated could void your authority to operate the equipment. Licensing of Shure wireless microphone equipment is the user's responsibility, and licensability depends on the user's classification and application, and on the selected frequency. Shure strongly urges the user to contact the appropriate telecommunications authority concerning proper licensing, and before choosing and ordering frequencies.

Certifications

Information to the user

This device complies with part 15 of the FCC Rules. Operation is subject to the following two conditions:

1. This device may not cause harmful interference.
2. This device must accept any interference received, including interference that may cause undesired operation.

Note: This equipment has been tested and found to comply with the limits for a Class B digital device, pursuant to part 15 of the FCC Rules. These limits are designed to provide reasonable protection against harmful interference in a residential installation. This equipment generates uses and can radiate radio frequency energy and, if not installed and used in accordance with the instructions, may cause harmful interference to radio communications. However, there is no guarantee that interference will not occur in a particular installation. If this equipment does cause harmful interference to radio or television reception, which can be determined by turning the equipment off and on, the user is encouraged to try to correct the interference by one or more of the following measures:

- Reorient or relocate the receiving antenna.
- Increase the separation between the equipment and the receiver.
- Connect the equipment to an outlet on a circuit different from that to which the receiver is connected.
- Consult the dealer or an experienced radio/TV technician for help.

This device complies with part 15 of the FCC Rules. Operation is subject to the following two conditions: (1) This device may not cause harmful interference, and (2) this device must accept any interference received, including interference that may cause undesired operation.

Certified under FCC Part 74.

Certified by ISED in Canada under RSS-102 and RSS-210.

Certified by ISED in Canada under RSS-247 and RSS-GEN.

IC: 616A-ULXD6G50, 616A-ULXD6H50, 616A-ULXD6J50, 616A-ULXD6X52, 616A-ULXD8G50, 616A-ULXD8H50, 616A-ULXD8J50, 616A-ULXD8X52.

FCC: DD4ULXD6G50, DD4ULXD6H50, DD4ULXD6J50, DD4ULXD6X52, DD4ULXD8G50, DD4ULXD8H50, DD4ULXD8J50, DD4ULXD8X52.

This product meets the Essential Requirements of all relevant European directives and is eligible for CE marking.

This device contains licence-exempt transmitter(s)/receiver(s) that comply with Innovation, Science and Economic Development Canada's licence-exempt RSS(s). Operation is subject to the following two conditions:

1. This device may not cause interference.
2. This device must accept any interference, including interference that may cause undesired operation of the device.

L'émetteur/récepteur exempt de licence contenu dans le présent appareil est conforme aux CNR d'Innovation, Sciences et Développement économique Canada applicables aux appareils radio exempts de licence. L'exploitation est autorisée aux deux conditions suivantes :

1. L'appareil ne doit pas produire de brouillage;
2. L'appareil doit accepter tout brouillage radioélectrique subi, même si le brouillage est susceptible d'en compromettre le fonctionnement.

Para maiores informações, consulte o site da ANATEL www.anatel.gov.br

Este equipamento não tem direito à proteção contra interferência prejudicial e não pode causar interferência em sistemas devidamente autorizados.

Note: EMC conformance testing is based on the use of supplied and recommended cable types. The use of other cable types may degrade EMC performance.

The CE Declaration of Conformity can be obtained from: www.shure.com/europe/compliance

Authorized European representative:

Shure Europe GmbH

Headquarters Europe, Middle East & Africa

Department: EMEA Approval

Jakob-Dieffenbacher-Str. 12

75031 Eppingen, Germany

Phone: +49-7262-92 49 0

Fax: +49-7262-92 49 11 4

Email: info@shure.de

- (一) 本产品符合“微功率短距离无线电发射设备目录和技术要求”的具体条款和使用场景；
- (二) 不得擅自改变使用场景或使用条件、扩大发射频率范围、加大发射功率（包括额外加装射频功率放大器），不得擅自更改发射天线；
- (三) 不得对其他合法的无线电台（站）产生有害干扰，也不得提出免受有害干扰保护；
- (四) 应当承受辐射射频能量的工业、科学及医疗（ISM）应用设备的干扰或其他合法的无线电台（站）干扰；
- (五) 如对其他合法的无线电台（站）产生有害干扰时，应立即停止使用，并采取措施消除干扰后方可继续使用；
- (六) 在航空器内和依据法律法规、国家有关规定、标准划设的射电天文台、气象雷达站、卫星地球站（含测控、测距、接收、导航站）等军民用无线电台（站）、机场等的电磁环境保护区域内使用微功率设备，应当遵守电磁环境保护及相关行业主管部门的规定。